

SONIC WAVE 5 BIKE RACK

Elevate your bike parking experience with the Sonic Wave Bike Rack. Its sleek design and robust security features have made it a preferred choice for schools and communities. Whether used in single-sided or double-sided configurations, this rack, with its thick pipe construction, ensures durability. Secure your bike with ease using a u-style bike lock to protect one wheel and frame.



 x 5 COST \$ \$ \$ \$

DIMENSIONS

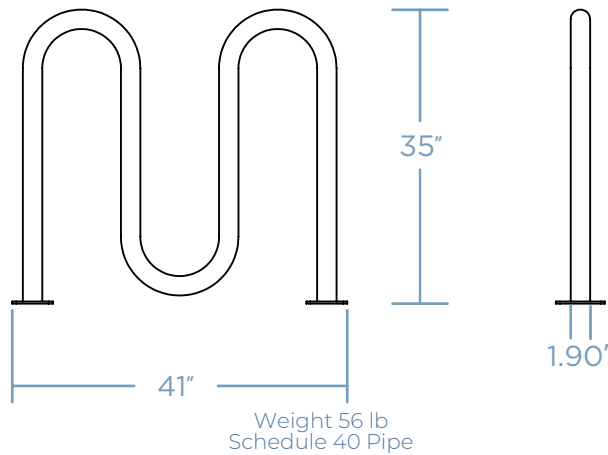

TUBE OPTIONS

STANDARD 1.9"

PRO 2.3/8" *

MOUNTING OPTIONS

SURFACE MOUNT



IN GROUND



FINISH OPTIONS

POWDER COAT

GALVANIZED STEEL

THERMOPLASTIC*

STAINLESS STEEL*

* will incur additional cost



QUANTITY _____

CUSTOMER _____

COLOR _____

PROJECT _____

DATE _____

APPROVED BY _____